

Fitness Equipment

FOR
YOUR HEALTHY



Instruction:
Stand on the plate, use both feet to hold the equipment and hold the handle with both hands. Push forward slowly with force and receive slowly. Repeat the same.

Function:
Strengthening the muscles of the upper limbs, increasing joint flexibility and improving the flexibility of the joints and coordination of the whole body and allows.

Notice:
Please don't overexert yourselves. A red circle shows the correct posture of the related parts.

www.greenfit.com.vn



ABOUT US 03

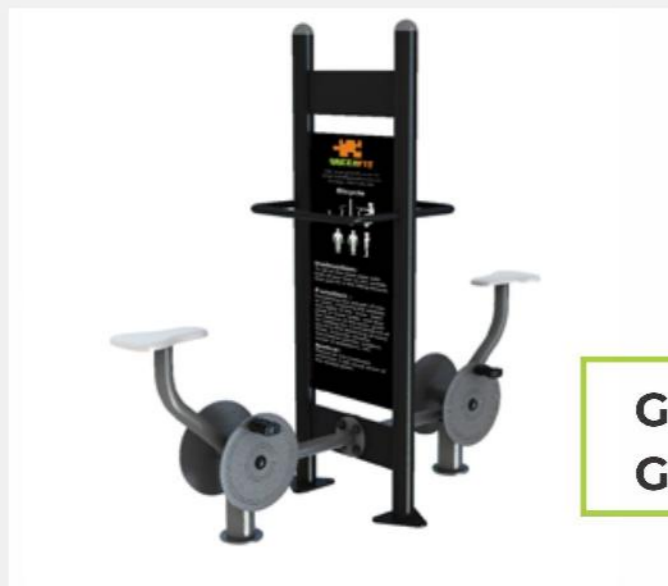

GREEN FIT GOTHENBURG 09

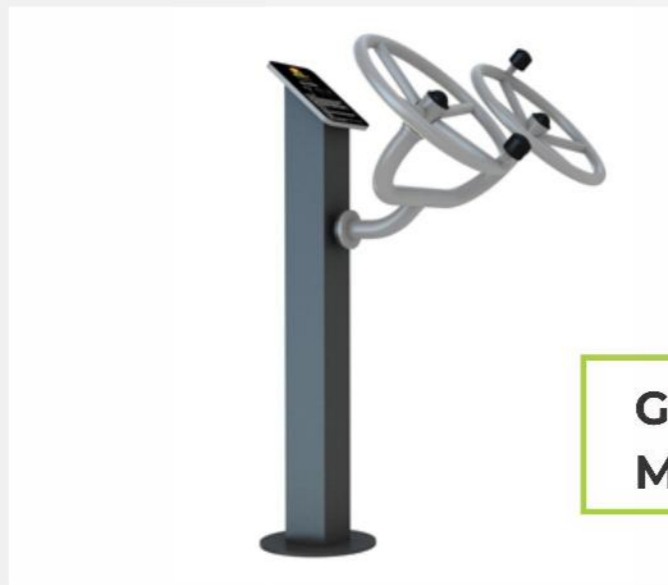

GREEN FIT MALMO 14

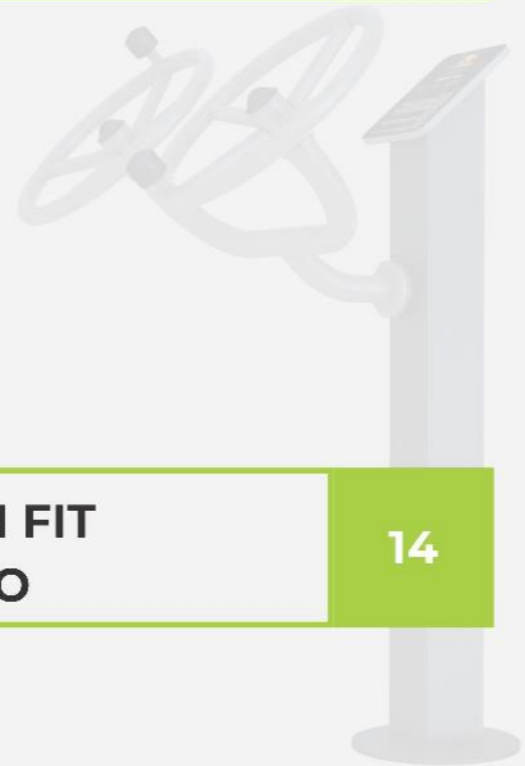

19 GREEN FIT SUNDSVALL

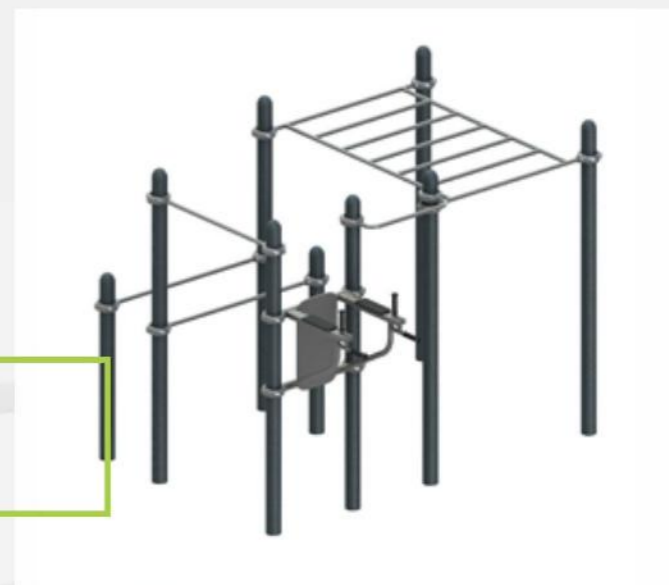

23 GREEN FIT STOCKHOLM



31 GREEN FIT UPPSALA





ABOUT US

Green Fit is a brand of TNTY specializing in providing the most professional outdoor fitness equipment. Leading experts design our products in Sweden.

We are the leading provider of outdoor fitness equipment to public and private parks, outdoor gyms, sports facilities, schools, and hospitals. As the industry leader, GREEN FIT has provided equipment to thousands of exercise, sporting, and fitness area installations around Vietnam and throughout the world.

Every day, millions of exercisers benefit from using Green Fit exercise equipment, from elite athletes to those just starting a workout routine.

We bring the value and sporty spirit in each product.



OUR MISSION

Our mission is to provide solutions that get the world moving and help people lead active and healthy lives.

The best way to know everything we can about our fitness products is to use them every day. Helping people live healthy lives is what we do.

OUR PHILOSOPHY

At GREEN FIT, we believe in striving to achieve impossible goals. We believe that helping people move and move more of their bodies contributes to a healthy, active, and vibrant future generation.



Green Fit brings a healthy community!

IDEAL OUTDOOR FITNESS SPACES

A healthy community needs a healthy heart. That heart can symbolize the mental and physical health of each person. It is also a place to help people exchange, meet, and exercise. It is where strangers become playmates and playmates become friends. It is where adults start conversations that become life-long bonds. It is where neighborhoods are defined and cities established.

Therefore, Green Fit will always strive to bring the ideal training space to bring people together, where all beliefs, cultures, or ages are no longer the limits.

A HEALTHY LIVING SPACE

The outdoor fitness space is a place where tired, stress, and unease should melt away in an atmosphere of local pride, trust, and love. It is where everybody puts down their phone to engage in physical activities and lead a healthier life.

At GREEN FIT, we value fitness equipment that is functional and designed to suit all audiences. Whether a child can safely practice a mono bar, an older person can easily use the treadmill most comfortably. We believe that sports space must be a place that brings happiness to the community.

ACCESS IS FOR ALL

The fitness spaces should be the center of a broad community. It does not belong to anyone or any individual or organization, so there is no isolation or discrimination. Everyone is equal and has the right to participate in exercise to improve health.

That is GREEN FIT's vision to build a happy, physically and mentally healthy community.

WHY CHOOSE GREEN FIT?

Customers

Green Fit is always here for the customer - today and the future. We will continuously strive for customers because you are the driving force to help us grow.

Quality

Green Fit is proud of high-qualified products and services, ensuring customer satisfaction.

Integrity

We are always heading to the right things to follow our mission.

HERE'S WHAT MAKES OUR EQUIPMENT SPECIAL?



Super Design

Functional goes hand-in-hand with beautiful. It inspires the practitioner every day.



Scientific Research

With our scientific knowledge, we exploit every aspect of our products to deliver the results you aim at it.



Innovative Equipment

We are always researching the best solutions to increase the efficiency of sports equipment.



THE BEST SOLUTION

OUTSTANDING PERFORMANCE ON ALL PARAMETERS



The highest standards

ISO 9001 certification approves the highest level of quality. We follow internal safety routines according to EN1176 (EU), ASTM (North America), supervised by acknowledged safety institutes. All Green Fit standard products are TÜV-certified. Critical parts are made of highly reliable steel and massive structures equipped with safety features providing double and triple safety.



The most innovative

Innovation is one of the fundamental drivers of everything at GREEN FIT. It's a never-ending process, driven by close collaboration with customers and experts, using technological development to improve our product.



Most beautiful and timeless fitness designs

Besides functional outdoor fitness equipment, GREEN FIT always focuses on product design to attract and inspire enthusiasm to exercise for users. Our top experts from Sweden have delivered the best experiences and design durable products over the years.



Highest quality materials

Our product stands for the wear and tear of weather and heavy usage. It looks great for decades to come and requires little to take care of, and users get as many hours of joy as possible. Therefore, we use the highest quality materials that look inviting for decades to come and require a minor maintenance amount.



Green and safe

The environment and safety go hand-in-hand on a GREEN FIT facility, one feature frequently complimenting the other. From raw materials to the final product, the ability to generate from recycled resources and then not leave a negative footprint is primary. It makes the fitness experience exciting.



The greatest experience

It is our mission to develop happier and healthier communities. So Green Fit products are to stimulate everybody's physical, social, cognitive, and creative skills. Physical challenges improve health, increase physical activity, motor skills, build muscle strength and durability.

OUR WARRANTY



01

Warranty coverage

This warranty applies to GREEN FIT's products for the periods described for each product type above and with the limitations described in this warranty. The warranty period applies from the date of purchase by the first customer.

This warranty covers only defects in materials. GREEN FIT's liability under this warranty is limited to repair or replacement of defective products, without charge, at GREEN FIT's discretion.



02

Proper installation and maintenance

The warranty only applies if GREEN FIT's products have been installed according to the instructions provided by GREEN FIT and maintained correctly according to the GREEN FIT Maintenance Manual.

Warranty exclusions

- The product has an expired warranty or no warranty card.
- Unilaterally disassemble, change product structure, replace or repair by any other third party.
- Cosmetic damage, including but not limited to scratches, chips, dents, cracks.
- Damage caused by accident, intentional, overuse, misuse, and instructions of the product.
- Damage is caused by arbitrarily using or installing third-party components or products that do not meet the specifications of products supplied or installed under the contract.
- Damage caused by poor storage conditions, fire, natural disaster, earthquake, and other unusual external power sources.
- Errors due to normal wear and tear or normal aging of the product.
- Parts consumed for damage due to failure to follow published instructions.



03



04

Near water installations

Products installed in direct contact with chlorinated water or salt water or products installed with occasional contact with such water or installed so close to the shore they are subjected to salt spray are not covered by the GREEN FIT warranty for any defects caused by corrosion.

The warranty will only cover standard products installed in coastal areas within 200 meters from the shore for half the period of the standard product warranty concerning defects caused by corrosion. If applicable, GREEN FIT's warranty is limited to a half-time warranty concerning such products.



GREEN FIT GOTHENBURG

Green Fit Gothenburg is our unique and convenient range of products with two devices with the same functionality in one product set. Gothenburg will bring satisfaction and a great experience when your family and companion always practice together.

Gothenburg focuses on stretching muscles by combining aerial walking exercises, hip rotation, chest tension to burn calories in a maximum way. Besides, stretching exercises are a great way to help blood circulation, oxygen, and nutrients that bring more muscle bundles, more muscle flexibility, flexible joints, and less straight tension.

Our Gothenburg outdoor fitness equipment collection, designed by top experts in Sweden, will make the most of the difference and impress.



GREEN FIT-1000

Function: Push Chair
Size(mm): 700 x 1900 x 2000
Material: Hot galvanized pipe, PE

Push Chair is a specific product for building strength in the chest and arm muscles. The exercise involves extending the arms in front of the body by pushing against the two levers. The design of the products allows for two people to work out together. The product is made from hot galvanized pipe material, coated with high-quality powder coating. Therefore, Green Fit's device has good rust resistance, high durability, and excellent outdoor weather conditions.



GREEN FIT-1001

Function: Bicycle
Size(mm): 600 x 1800 x 2000
Material: Hot galvanized pipe, PE

Bicycle is an excellent way to improve cardiovascular fitness. Furthermore, it goes easy on the knees and joints, making it ideal for everyone. The design of the products allows for two people to work out together. The product is made from hot galvanized pipe material, coated with high-quality powder coating. Therefore, Green Fit's device has good rust resistance, high durability, and excellent outdoor weather conditions.



GREEN FIT-1002

Function: Elliptical Cross Trainer
Size(mm): 600 x 3600 x 2000
Material: Hot galvanized pipe, PE

Elliptical Cross Trainer is perfect for those looking to improve your fitness. During the workout you will experience a mild resistance only, making it easy on knees and joints while still providing an optimal exercise for people to improve their personal fitness. The design of the products allows for two people to work out together.
The product is made from hot galvanized pipe material, coated with high-quality powder coating. Therefore, Green Fit's device has good rust resistance, high durability, and excellent outdoor weather conditions.



GREEN FIT-1003

Function: Spacwalker
Size(mm): 800 x 2600 x 2000
Material: Hot galvanized pipe, PE

Spacewalker trains your lower body with an even muscle resistance of no impact. You can immediately step up and start running at an intensity of your personal preference. The design of the products allows for two people to work out together.
The product is made from hot galvanized pipe material, coated with high-quality powder coating. Therefore, Green Fit's device has good rust resistance, high durability, and excellent outdoor weather conditions.



GREEN FIT-1004

Function: Waist Movement Trainer
Size(mm): 600 x 1500 x 2000
Material: Hot galvanized pipe, PE

Waist Movement Trainer trains your lower body, especially the waist point. It helps to train joints and enhance their flexibility and the cardiopulmonary function. The design of the products allows for two people to work out together.
The product is made from hot galvanized pipe material, coated with high-quality powder coating. Therefore, Green Fit's device has good rust resistance, high durability, and excellent outdoor weather conditions.



GREEN FIT-1005

Function: Taiji Wheel
Size(mm): 900 x 1000 x 2000
Material: Hot galvanized pipe, PE

According to the basic principle of Taiji, the joint movements of the shoulders, elbows, hip, knees, and hands are suitable for the blood circulation, activate the muscles and bones, and strengthen muscles' flexibility. The design of the products allows for two people to work out together.
The product is made from hot galvanized pipe material, coated with high-quality powder coating. Therefore, Green Fit's device has good rust resistance, high durability, and excellent outdoor weather conditions.



GREEN FIT-1006

Function: Parallerbar
Size(mm): 600 x 2500 x 2000
Material: Hot galavnized pipe, PE

Parallerbar is easy to train your body. You hold with both hands grip tightly on the horizontal bar, lift the body up and down. The design of the products allows for two people to work out together.
The product is made from hot galvanized pipe material, coated with high-quality powder coating. Therefore, Green Fit's device has good rust resistance, high durability, and excellent outdoor weather conditions.



GREEN FIT MALMO

The product line with a sturdy and robust design is suitable for specialized outdoor sports areas. In particular, the Malmo collection focuses only on popular muscle groups such as abdominal, back, and thigh muscles.

Additionally, our sports gear is intuitive, lively, and easy to train for beginners. Using the Malmo device will help you improve your health, especially for cardiovascular problems, and boost your metabolism. From there, it helps prevent cardiovascular diseases, diabetes, blood fat, and blood pressure.

When exercising with Green Fit Malmo, each movement will affect large and small muscle groups, stimulate nerves more excitement, and effectively relieve stress. All ages with all abilities can practice in which the elderly if they practice the suitable method, will make them healthier, more resilient, or the young will help them become more energetic, agile, and active.





GREEN FIT-2000

Function: Pull chair
Size(mm): 700x1500x1700
Material: Hot galvanized pipe

Pull Chair is a specific product for building strength in the chest and arm muscles. The exercise involves narrow the arms in front of the body by pulling against the two levers. The product is made from hot galvanized pipe material, coated with high-quality powder coating. Therefore, Green Fit's device has good rust resistance, high durability, and excellent outdoor weather conditions.



GREEN FIT-2002

Function: Bicycle
Size(mm): 600x1100x1300
Material: Hot galvanized pipe

Bicycle is an excellent way to improve cardiovascular fitness. Furthermore, it goes easy on the knees and joints, making it ideal for everyone. The product is made from hot galvanized pipe material, coated with high-quality powder coating. Therefore, Green Fit's device has good rust resistance, high durability, and excellent outdoor weather conditions.



GREEN FIT-2001

Function: Combination of waist movement, Surfboard & Stepper
Size(mm): 1500x1700x1400
Material: Hot galvanized pipe

Product is a combination of waist and leg muscles training on one device. The design of the products allows for two people to work out together. The product is made from hot galvanized pipe material, coated with high-quality powder coating. Therefore, Green Fit's device has good rust resistance, high durability, and excellent outdoor weather conditions.



GREEN FIT-2003

Function: Taiji Wheel
Size(mm): 800x900x1300
Material: Hot galvanized pipe

According to the basic principle of Taiji, the joint movements of the shoulders, elbows, hip, knees, and hands are suitable for the blood circulation, activate the muscles and bones, and strengthen muscles' flexibility. The product is made from hot galvanized pipe material, coated with high-quality powder coating. Therefore, Green Fit's device has good rust resistance, high durability, and excellent outdoor weather conditions.



GREEN FIT-2004

Function: Trainer
Size(mm): 700x1500x1700
Material: Hot galvanized pipe

Trainer is perfect for those looking to improve your fitness. During the workout you will experience a mild resistance only, making it easy on knees and joints while still providing an optimal exercise for people to improve their personal fitness. The product is made from hot galvanized pipe material, coated with high-quality powder coating. Therefore, Green Fit's device has good rust resistance, high durability, and excellent outdoor weather conditions.



GREEN FIT-2006

Function: Paralleb bar
Size(mm): 700x1400x1300
Material: Hot galvanized pipe

Paralleb bar is easy to train your body. You hold with both hands grip tightly on the horizontal bar, lift the body up and down. The product is made from hot galvanized pipe material, coated with high-quality powder coating. Therefore, Green Fit's device has good rust resistance, high durability, and excellent outdoor weather conditions.



GREEN FIT-2005

Function: Waist movement trainer
Size(mm): 600x1100x1400
Material: Hot galvanized pipe

Waist Movement Trainer trains your lower body, especially the waist point. It helps to train joints and enhance their flexibility and the cardiopulmonary function. The product is made from hot galvanized pipe material, coated with high-quality powder coating. Therefore, Green Fit's device has good rust resistance, high durability, and excellent outdoor weather conditions.



GREEN FIT-2007

Function: Wab board
Size(mm): 800x1700x1200
Material: Hot galvanized pipe

Using the Wab board will strengthen the abdominal wall by improving muscle endurance and strength. Users can develop their posture and also work preemptively to prevent back problems. The product is made from hot galvanized pipe material, coated with high-quality powder coating. Therefore, Green Fit's device has good rust resistance, high durability, and excellent outdoor weather conditions.



GREEN FIT SUNDSVALL

Keeping up with the trend, Green Fit Sundsvall is a product line supporting the Street Workout (street sports). It is a novel sport that uses the body's weight while incorporating other sports such as track and field, gymnastics, and solitary bar during training.

It's not just a practice method, but also a new way of life, a unique style for those who practice, especially young people in big cities. In addition to the health benefits, Street workout also trains the will and resilience to overcome the challenges like conquering the peaks in training.

Our Swedish design experts have researched and launched the Green Fit Sundsvall range of flexible and easy difficulty to provide learners with an excellent and exciting experience.

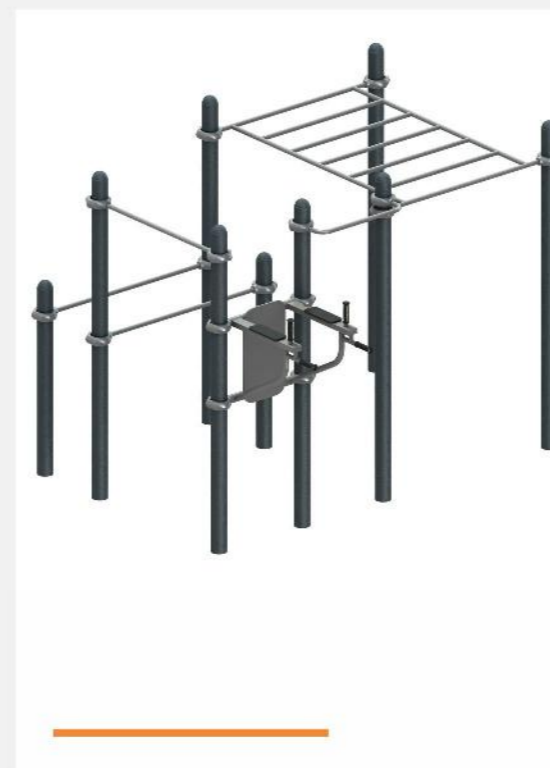

GREEN FIT-3000

Function: Training equipment monkey bar workout

Size(mm): 3000 x 2500 x 2550

Material: Hot galvanized Material, PE

Training equipment monkey bar workout is wide and high to ensure anyone can hang and move freely. The complete street workout experience features all essential elements while inviting users to find their way from one side to another creatively. As such, it is perfect for parkour, allowing for an infinite range of movement.

The product is made from hot galvanized pipe material, coated with high-quality powder coating. Therefore, Green Fit's device has good rust resistance, high durability, and excellent outdoor weather conditions.



GREEN FIT-3001

Function: Multi functional Cross Fitness monkey Rig

Size(mm): 7360 x 660 x 2050

Material: Hot galvanized pipe, PE

Multi functional Cross Fitness monkey Rig is wide and high to ensure anyone can hang and move freely. The complete street workout experience features all essential elements while inviting users to find their way from one side to another creatively. As such, it is perfect for parkour, allowing for an infinite range of movement.

The product is made from hot galvanized pipe material, coated with high-quality powder coating. Therefore, Green Fit's device has good rust resistance, high durability, and excellent outdoor weather conditions.



GREEN FIT-3002

Function: Street workout
Size(mm): 4500 x 4500 x 2550
Material: Hot galvanized pipe, PE

Elliptical Cross Trainer is perfect for those looking to improve your fitness. During the workout you will experience a mild resistance only, making it easy on knees and joints while still providing an optimal exercise for people to improve their personal fitness. The design of the products allows for two people to work out together.

The product is made from hot galvanized pipe material, coated with high-quality powder coating. Therefore, Green Fit's device has good rust resistance, high durability, and excellent outdoor weather conditions.



GREEN FIT-3003

Function: Street workout
Size(mm): 3000 x 3000 x 2550
Material: Hot galvanized pipe, PE

Street workout is wide and high to ensure anyone can hang and move freely. The complete street workout experience features all essential elements while inviting users to find their way from one side to another creatively. As such, it is perfect for parkour, allowing for an infinite range of movement.

The product is made from hot galvanized pipe material, coated with high-quality powder coating. Therefore, Green Fit's device has good rust resistance, high durability, and excellent outdoor weather conditions.



GREEN FIT-3004

Function: Leg Presser Trainer
Size(mm): 4500 x 600 x 700
Material: Hot galvanized pipe, PE

The Leg Presser Trainer provides excellent training for the core and lowers back muscles by doing exercises such as leg lifts and sit-ups. Comfortable grips are created to make sure anyone can correctly do the practice.

The product is made from hot galvanized pipe material, coated with high-quality powder coating. Therefore, Green Fit's device has good rust resistance, high durability, and excellent outdoor weather conditions.



GREEN FIT-3005

Function: Overhead Ladder
Size(mm): 2100 x 1500 x 2450
Material: Hot galvanized pipe, PE

The overhead ladder, also known as the monkey bar, may be the most famous of all obstacle course elements. The goal is to get to the other side without using your feet. This overhead ladder is wide and high to ensure anyone can hang and move freely.

The product is made from hot galvanized pipe material, coated with high-quality powder coating. Therefore, Green Fit's device has good rust resistance, high durability, and excellent outdoor weather conditions.



GREEN FIT STOCKHOLM

Green Fit Stockholm is a diversified and flexible product line that combines many different sports. These include stretching exercises, shaking or rotating hips, crunches, single beams, and especially one or more people can be exercised on the same equipment.

Stockholm's design is safe, simple, and easy to practice, even for the first-time experience. Each of our devices will be compatible with each muscle group on the body you want to target, practice persistently and adequately every day; you will have a desirable physique and gradually improve your health.

These exercises will help increase and control the heart rate, support increased blood circulation. From there provides more oxygen to the whole body and muscle cells, allowing the cells to burn excess fat more efficiently during exercise and at rest.

Green Fit Stockholm will be the perfect choice for public sports areas in parks, residential areas, where all ages and abilities can practice their way in the best way.



GREEN FIT-4000

Function: Parallel Bars
Size(mm): 1970 x 542 x 600
Material: Hot galvanized pipe, PE

Parallel Bars is easy to train your body. You hold with both hands grip tightly on the horizontal bar, lift the body up and down. The design of the products allows for two people to work out together.

The product is made from hot galvanized pipe material, coated with high-quality powder coating. Therefore, Green Fit's device has good rust resistance, high durability, and excellent outdoor weather conditions.



GREEN FIT-4001

Function: Elliptical cross trainer
Size(mm): 1176 x 641 x 1660
Material: Hot galvanized pipe, PE

Elliptical Cross Trainer is perfect for those looking to improve your fitness. During the workout you will experience a mild resistance only, making it easy on knees and joints while still providing an optimal exercise for people to improve their personal fitness.

The product is made from hot galvanized pipe material, coated with high-quality powder coating. Therefore, Green Fit's device has good rust resistance, high durability, and excellent outdoor weather conditions.



GREEN FIT-4002

Function: Taiji Wheel
Size(mm): 1210 x 10000 x 1320
Material: Hot galvanized pipe

According to the basic principle of Taiji, the joint movements of the shoulders, elbows, hip, knees, and hands are suitable for the blood circulation, activate the muscles and bones, and strengthen muscles' flexibility. The design of the products allows for two people to work out together. The product is made from hot galvanized pipe material, coated with high-quality powder coating. Therefore, Green Fit's device has good rust resistance, high durability, and excellent outdoor weather conditions.



GREEN FIT-4003

Function: Surfboard
Size(mm): 1080 x 920 x 1450
Material: Hot galvanized pipe

Using Surfboard with two feet, hold the two handles, utilize the waist strength to move the legs like a pendulum to feet, have the two handles. The design of the products allows for two people to work out together. The product is made from hot galvanized pipe material, coated with high-quality powder coating. Therefore, Green Fit's device has good rust resistance, high durability, and excellent outdoor weather conditions.



GREEN FIT-4004

Function: Arm wheel and bicycle
Size(mm): 854 x 615 x 1377
Material: Hot galvanized pipe+ PE plate

To use Arm wheel and bicycle, you sit on the seat board, put the feet on the pedals, while both hands grip handle, make the coordination of reciprocating movement, and do separately exercise by feet or hands. Or you can work both arms and legs at the same time. The product is made from hot galvanized pipe material, coated with high-quality powder coating. Therefore, Green Fit's device has good rust resistance, high durability, and excellent outdoor weather conditions.



GREEN FIT-4005

Function: Waist Movement
Size(mm): 1530 x 1368 x 1550
Material: Hot galvanized pipe

Waist Movement trains your lower body, especially the waist point. It helps to train joints and enhance their flexibility and the cardiopulmonary function. The design of the products allows for three people to work out together. The product is made from hot galvanized pipe material, coated with high-quality powder coating. Therefore, Green Fit's device has good rust resistance, high durability, and excellent outdoor weather conditions.



GREEN FIT-4006

Function: Double-unit Walker
Size(mm): 2400x800x1500
Material: Hot galvanized pipe

Double-unit Walker can train the upper body and core stability. The rounded corners make it easy to swing your legs across this device, making it safe to try new tricks without the risk of injuries.

The product is made from hot galvanized pipe material, coated with high-quality powder coating. Therefore, Green Fit's device has good rust resistance, high durability, and excellent outdoor weather conditions.



GREEN FIT-4008

Function: Ring Trainer
Size(mm): 880x560x1080
Material: Hot galvanized pipe

Using Ring Trainer, you sit and hold the two handles, put the feet onto footboards, utilize your weight to pull and stretch the legs, and then return to sitting position. Repeat the cycle.

The product is made from hot galvanized pipe material, coated with high-quality powder coating. Therefore, Green Fit's device has good rust resistance, high durability, and excellent outdoor weather conditions.



GREEN FIT-4007

Function: Uneven Bars
Size(mm): 2750x114x2400
Material: Hot galvanized pipe

Uneven Bars can train the upper body and core stability. This bar is 240 cm high, enough to perform dips with extended legs. The rounded corners make it easy to swing your legs across Uneven Bars, making it safe to try new tricks without the risk of injuries.

The product is made from hot galvanized pipe material, coated with high-quality powder coating. Therefore, Green Fit's device has good rust resistance, high durability, and excellent outdoor weather conditions.



GREEN FIT-4009

Function: Sit-up Platform
Size(mm): 1800x690x820
Material: Hot galvanized pipe

Using the Sit-up Platform will strengthen the abdominal wall by improving muscle endurance and strength. Users can develop their posture and also work preemptively to prevent back problems.

The product is made from hot galvanized pipe material, coated with high-quality powder coating. Therefore, Green Fit's device has good rust resistance, high durability, and excellent outdoor weather conditions.



GREEN FIT-4010

Function: Seated Pedal Trainer
Size(mm): 2070 x 564 x 1640
Material: Hot galvanized pipe+ PE plate

Using Seated Pedal Trainer sit and hold the two handles, put the feet onto footboards, utilize own weight to push and stretch the legs, and then return to sitting position. The design of the products allows for two people to work out together.

The product is made from hot galvanized pipe material, coated with high-quality powder coating. Therefore, Green Fit's device has good rust resistance, high durability, and excellent outdoor weather conditions.



GREEN FIT-4012

Function: Space Walker
Size(mm): 750 x 1060 x 1250
Material: Hot galvanized pipe

Space walker trains your lower body with an even muscle resistance of no impact. You can immediately step up and start running at an intensity of your personal preference.

The product is made from hot galvanized pipe material, coated with high-quality powder coating. Therefore, Green Fit's device has good rust resistance, high durability, and excellent outdoor weather conditions.



GREEN FIT-4011

Function: Push Chair
Size(mm): 2344 x 672 x 1885
Material: Hot galvanized pipe+ PE plate

Push Chair is a specific product for building strength in the chest and arm muscles. The exercise involves extending the arms in front of the body by pushing against the two levers. The design of the products allows for two people to work out together.

The product is made from hot galvanized pipe material, coated with high-quality powder coating. Therefore, Green Fit's device has good rust resistance, high durability, and excellent outdoor weather conditions.



GREEN FIT-4013

Function: Trainer
Size(mm): 1164 x 641 x 1655
Material: Hot galvanized pipe

Trainer is perfect for those looking to improve your fitness. During the workout you will experience a mild resistance only, making it easy on knees and joints while still providing an optimal exercise for people to improve their personal fitness.

The product is made from hot galvanized pipe material, coated with high-quality powder coating. Therefore, Green Fit's device has good rust resistance, high durability, and excellent outdoor weather conditions.



GREEN FIT UPPSALA

Green Fit Uppsala offers a unique design with a conical leaf roof that is very pure Asian style. It is our convenient range of products with two devices with the same functionality in one product set. Uppsala will bring satisfaction and a great experience when your family and companion always practice together.

Uppsala focuses on stretching muscles by combining aerial walking exercises, hip rotation, chest tension to burn calories in a maximum way. Besides, stretching exercises are a great way to help blood circulation, oxygen, and nutrients that bring more muscle bundles, more muscle flexibility, flexible joints, and less straight tension.

Our Uppsala outdoor fitness equipment collection, designed by top experts in Sweden, will make the most of the difference and impress.

Green Fit is proud to be the leading brand in providing outdoor fitness equipment for adults and children of all ages. Explore our outdoor fitness solutions and discover how you can promote public health, an active lifestyle, wellness, and fitness where you live.



GREEN FIT-5000

Function: Taiji Wheel+ Waist Movement +Parallel Bar

Size(mm): 1943 x 2427 x 2648

Material: Hot galavernized pipe, Roof is steel plate

GREEN FIT-5000 is a combination of arm and waist muscles training on one device. The unique design with a conical-conical roof makes it fun to exercise. The design of the products allows for two people to work out together. The product is made from hot galvanized pipe material, coated with high-quality powder coating. The roof is a steel plate. Therefore, Green Fit's device has good rust resistance, high durability, and excellent outdoor weather conditions.



GREEN FIT-5001

Function: Push Chair+Space Walker +Parallel Bar

Size(mm): 2335 x 2926 x 2648

Material: Hot galavernized pipe, Roof is steel plate

It is a combination of chest – arm muscles and leg muscles training on one device. The unique design with a conical-conical roof makes it fun to exercise. The design of the products allows for two people to work out together. The product is made from hot galvanized pipe material, coated with high-quality powder coating. The roof is a steel plate. Therefore, Green Fit's device has good rust resistance, high durability, and excellent outdoor weather conditions.



GREEN FIT-5002

Function: Push Chair+Pull Chair
+Waist Movement
Size(mm): 2063 x 2025 x 2648
Material: Hot galavernized pipe, Roof is steel plate

GREEN FIT-5002 is a combination of chest – arm muscles and waist muscles training on one device. The unique design with a conical-conical roof makes it fun to exercise. The design of the products allows for two people to work out together.

The product is made from hot galvanized pipe material, coated with high-quality powder coating. The roof is a steel plate. Therefore, Green Fit's device has good rust resistance, high durability, and excellent outdoor weather



GREEN FIT-5003

Function: Pull Chair+Space walker+Elliptical
Cross Trainer
Size(mm): 3228 x 2726 x 2648
Material: Hot galavernized pipe,
Roof is steel plate

GREEN FIT-5003 is a combination of leg muscles training on one device. The unique design with a conical-conical roof makes it fun to exercise. The design of the products allows for two people to work out together.

The product is made from hot galvanized pipe material, coated with high-quality powder coating. The roof is a steel plate. Therefore, Green Fit's device has good rust resistance, high durability, and excellent outdoor weather conditions.

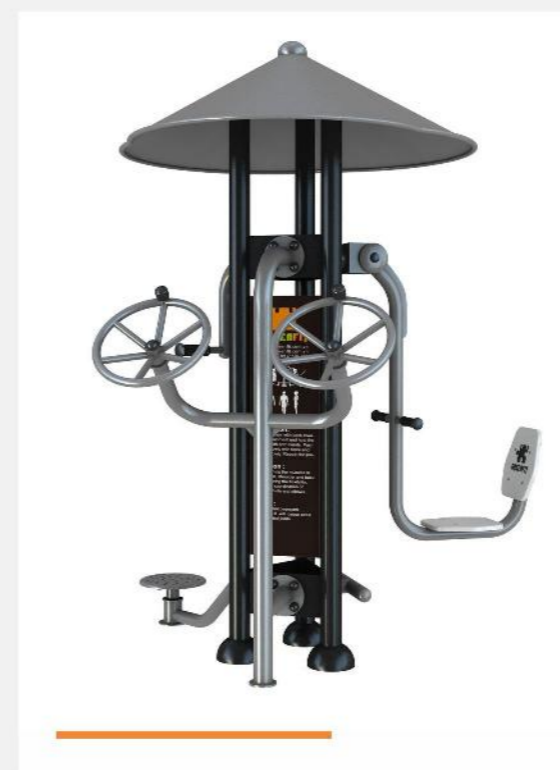

GREEN FIT-5004

Function: Taiji Wheel+ Waist Movement
+Seated Press Trainer
Size(mm): 1868 x 2058 x 2648
Material: Hot galavernized pipe,
Roof is steel plate

It is a combination of arm and leg muscles training on one device. The unique design with a conical-conical roof makes it fun to exercise. The design of the products allows for two people to work out together.

The product is made from hot galvanized pipe material, coated with high-quality powder coating. The roof is a steel plate. Therefore, Green Fit's device has good rust resistance, high durability, and excellent outdoor weather conditions.



GREEN FIT-5005

Function: Pull Chair+Space walker+Seated
Press Trainer
Size(mm): 2281 x 2589 x 2648
Material: Hot galavernized pipe,
Roof is steel plate

It is a combination of leg muscles training on one device. The unique design with a conical-conical roof makes it fun to exercise. The design of the products allows for two people to work out together.

The product is made from hot galvanized pipe material, coated with high-quality powder coating. The roof is a steel plate. Therefore, Green Fit's device has good rust resistance, high durability, and excellent outdoor weather conditions.

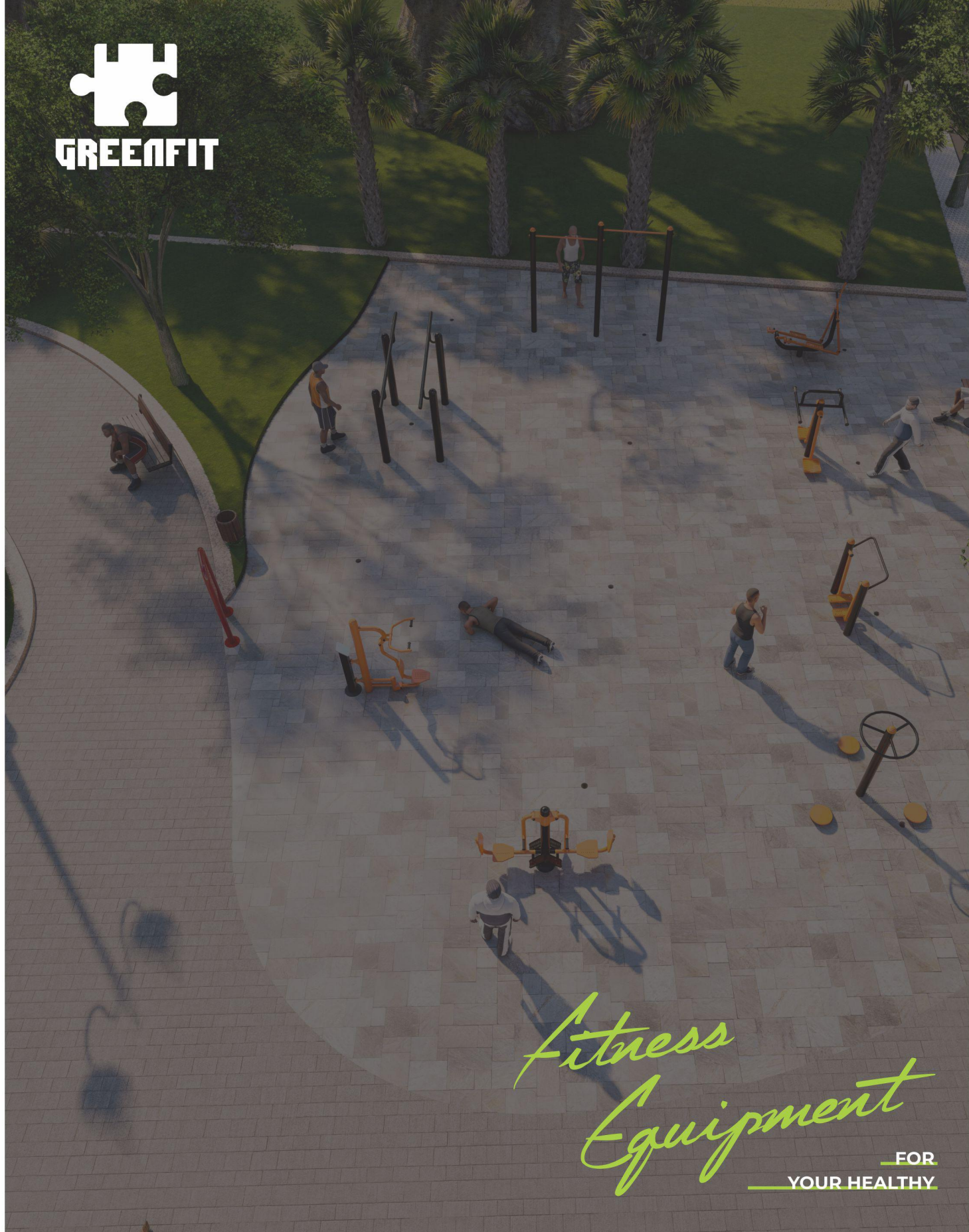

*Fitness
Equipment*
FOR
YOUR HEALTHY

TNTY GROUP – VIET NAM OFFICE

Add: SAV6-01.01, 1st floor, Tower 6, The Sun Avenue Building,
No. 28 Mai Chi Tho street, An Phu ward, Thu Duc city,
Ho Chi Minh city, Viet Nam

Hotline: +84 937 501 501 | **Tel:** +84 28 66 89 8888

Email: info@tntygroup.com

TNTY GROUP – SWEDEN OFFICE

Add: Vretenvägen 13B, 171 54 Solna,
Sweden

Tel: +46 842 002 688

Email: info@tntygroup.com